

XDTP61.1 / ...615.1 / ...62.1 / ...63.1

DOTS & STRIPES

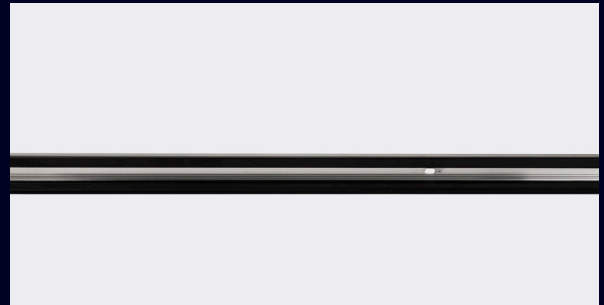
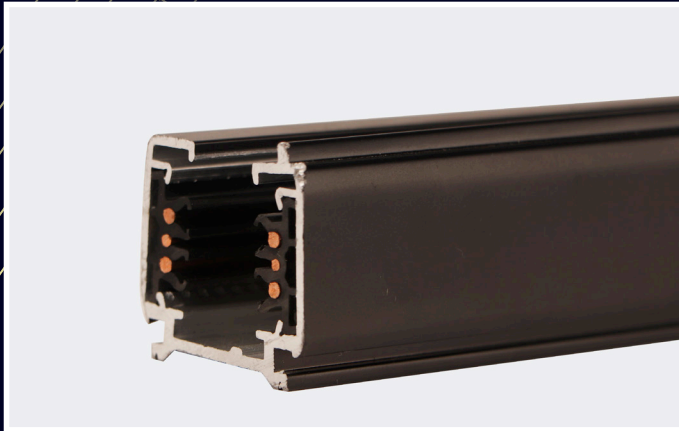

PRECAUCIÓN

Es necesario realizar una buena instalación, el producto no está protegido contra el agua, su uso se limita exclusivamente a interiores.

DOTS & STRIPES

RAIL

- Riel de 6 entradas y 3 circuitos.
- Ideal para uso en galerías, hoteles, museos, salones de exposiciones, joyerías, tiendas de ropa y supermercados.
- Uso únicamente interior.
- Utilizado para iluminación de énfasis y general.
- Acabado en color negro o blanco.

PARÁMETROS

Entradas 6 entradas

Circuitos 3 circuitos

Longitud
1 m (Código XDTP61.1)
1.5 m (Código XDTP615.1)
2 m (Código XDTP62.1)
3 m (Código XDTP63.1)

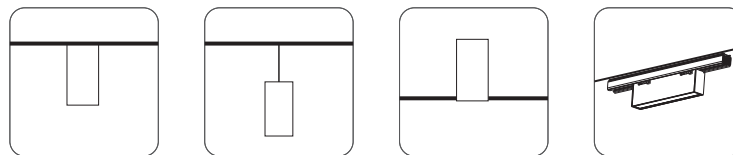
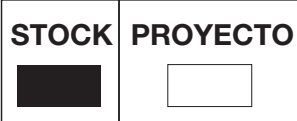

DIAGRAMA

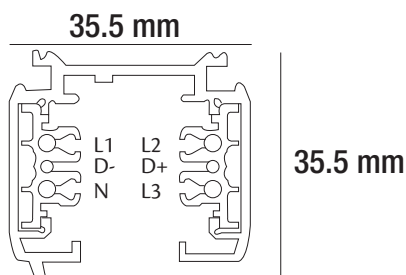

1000 mm / 1500mm
2000 mm / 3000mm

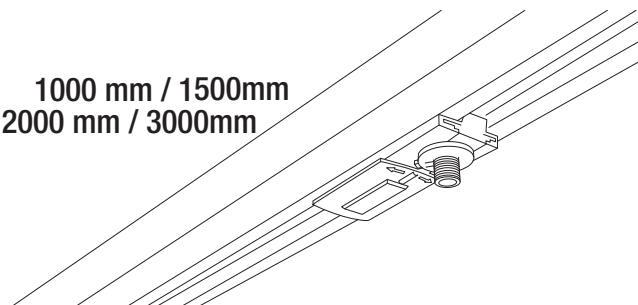

XDTP61.1 / ...615.1 / ...62.1 / ...63.1

EQUIPO AUXILIAR

CONECTOR
XDTFP.1



Conector para riel 6 entradas , 3 circuitos, configuración izquierda

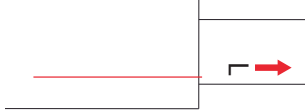

CONECTOR
XDTFP.2



Conector para riel 6 entradas , 3 circuitos, configuración derecha

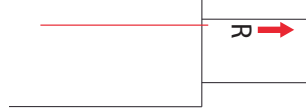

CONECTOR EN "X"
XDTCX.1



Conector en "X" para riel 6 entradas, 3 circuitos

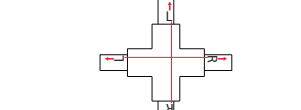

CONECTOR EN "I"
XDTCI.2



Conector intermedio "I" para riel 6 entradas, 3 circuitos

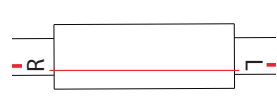

CONECTOR EN "L"
XDTCI.1



Conector en "L" configuración izquierda para riel 6 entradas, 3 circuitos

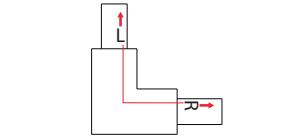

CONECTOR EN "L"
XDTCI.2



Conector en "L" configuración derecha para riel 6 entradas, 3 circuitos

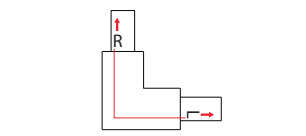

MINI CONECTOR
XDTCI.1



Mini conector intermedio "I" para riel 6 entradas, 3 circuitos



CONECTOR FLEXIBLE
XDTCF.1



Conector flexible para riel 6 entradas, 3 circuitos

CONECTOR EN "T"
XDTCI.1



Conector en "T" configuración abajo y derecha para riel 6 entradas, 3 circuitos

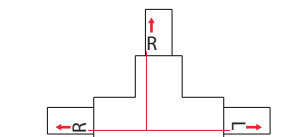

CONECTOR EN "T"
XDTCI.2



Conector en "T" configuración abajo e izquierda para riel 6 entradas, 3 circuitos

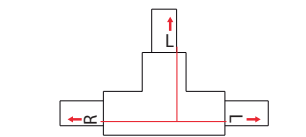

CONECTOR EN "T"
XDTCI.3



Conector en "T" configuración arriba e izquierda para riel 6 entradas, 3 circuitos

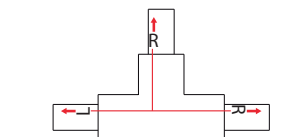

CONECTOR EN "T"
XDTCI.4



Conector en "T" configuración arriba y derecha para riel 6 entradas, 3 circuitos

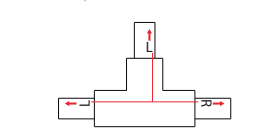

TAPA FINAL
XDTFE.1



Tapa final para riel 6 entradas, 3 circuitos

KIT DE SUSPENSIÓN
XDTKS.1



Kit de suspensión para montar en techo para riel 6 entradas, 3 circuitos, L= 1.5 m